

Machine Protection Door

ASSA ABLOY RP2000

ASSA ABLOY

ASSA ABLOY Entrance Systems

The global leader in
door opening solutions



ASSA ABLOY RP2000

- Type tested machine protection door with aluminum door blade
- Safety limit switches according to EN ISO 13849-1 and EN 62061
- Doors conform to EN ISO 12100 and EN ISO 14119
- For continuous operation with up to 5 openings per minute
- Versions conforming to various factory standards are possible
- High reliability even after years of high numbers of cycles

DOOR DESIGN

The side frames are self-supporting and made of galvanized steel shoot sections. The top roll cover is made of anodized aluminum, motor cover is made of painted steel. The side frames can be powder-coated in many RAL colors.

DOOR CURTAIN

The stable, rigid door curtain is made from anodized aluminum slats.

Optional: For process monitoring when the door is closed, slats with windows made of shockproof polycarbonate are optionally available. The aluminum slats are available powder-coated in all standard RAL colors.

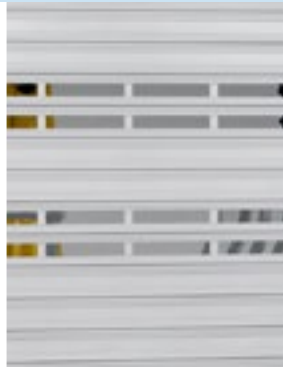

CURTAIN FOR LASER PROTECTION

ASSA ABLOY RP2000 was specifically developed for Laser Protection areas.

For this application the door is equipped with double walled slats prevent penetration from laser beams.

(Powder coating option is not available.)

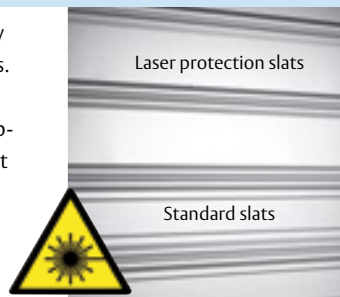

SAFETY FEATURES

The door has a pre-running photocell (1). As an option, a door line photocell (2) can be chosen, that prevents the door from closing while objects or people are in the closing level.

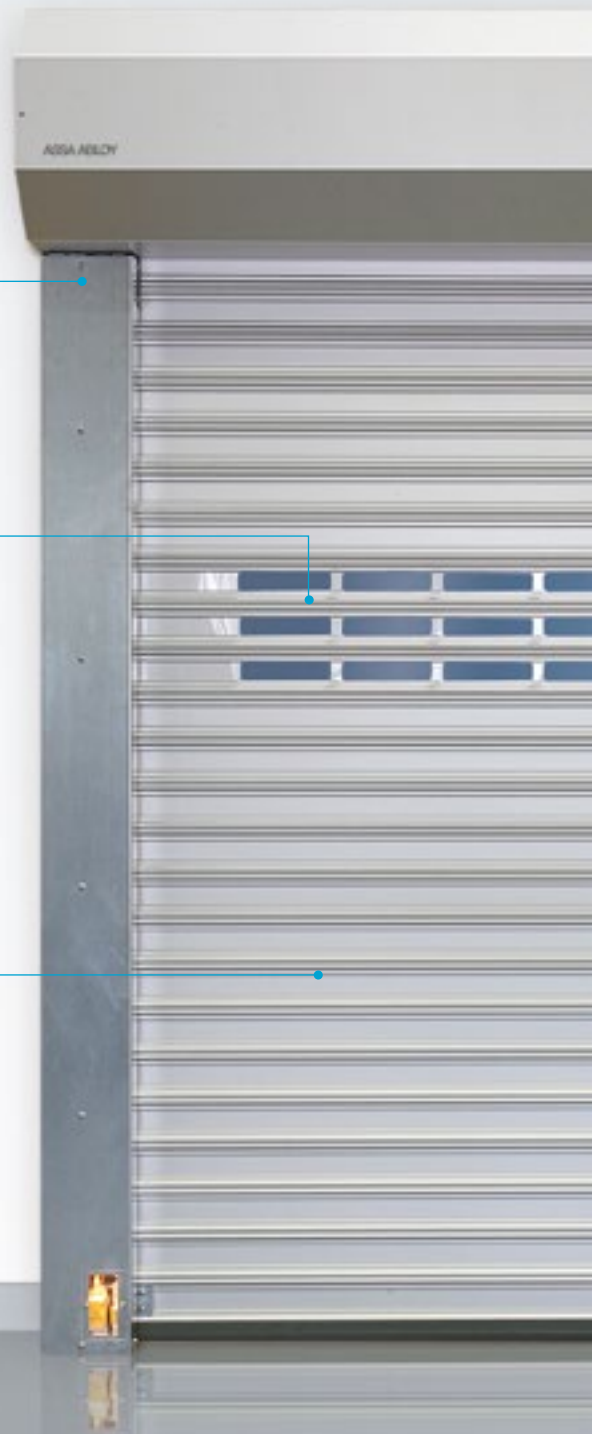
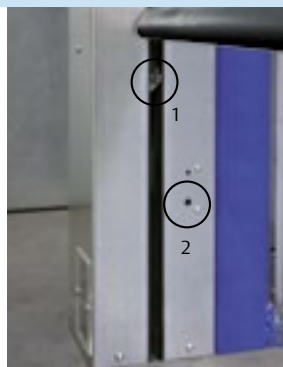

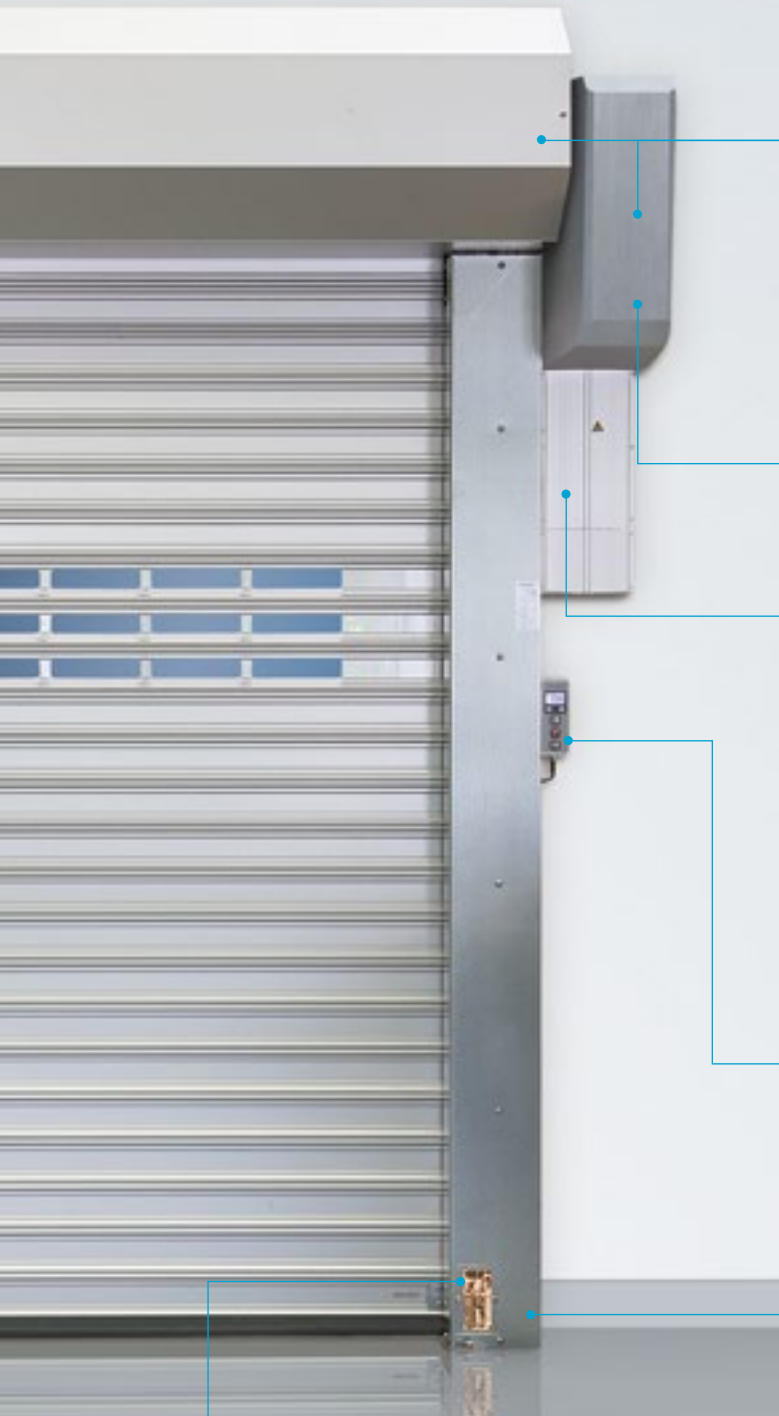

MOTOR COVER AND TOP ROLL COVER

The door can be fitted with a motor and top roll cover when needed. For doors of height < 2,5 m the use of top roll cover is required according to standard EN 13241-1.



MOTOR POSITION

Motor can be fitted on the right- or lefthand side.

CONTROL SYSTEM

The high performance frequency control MCC is installed underneath the drive unit without requiring a lot of space. It gives the door a particularly dynamic run with short cycle times. The microprocessor control makes individual programming for special customer demands possible.



CONTROL UNIT

Optional: display for operation, start-up and error reports. The display can be used to operate several doors.



SAFETY LIMIT SWITCHES INTEGRATED IN THE SIDE FRAME

For the indication "door safely closed", safety limit switches according to PL e/Kat. 4 (EN ISO 13849-1), SIL 3 (EN 62061) are integrated in the side frame (2 units for the laser version).

Delivered with safety monitoring module.

Transparent cover for safety limit switches for easy monitoring and accessibility.

Optional evaluation by the machines safety systems (versions without safety monitoring module).



FLOOR MOUNTING BRACKETS

The door can be mounted free-standing on floor with floor mounting brackets. Levelling screws allow adjustment by uneven floor.



Machine Protection Door ASSA ABLOY RP2000

Both the automotive industry and other industrial sectors place equally stringent demands on automated manufacturing processes. Even the smallest error can result in downtimes and put employees at risk. Machine protection doors are an effective safety measure, providing optimal protection for personnel and machines without adversely affecting cycle times. They enable a rapid switch from complete isolation of a production stage to unimpeded access to the workpiece and machine in a matter of seconds, effectively protecting personnel from flying sparks, welding spatter etc.

Advantages of ASSA ABLOY RP2000 machine protection doors

- With a ridged, reinforced curtain made from aluminium slats, the ASSA ABLOY RP2000 provides complete protection, even from deflection of the curtain.
- The slats are connected with side-mounted flat belts for contact-free winding, which ensures:
 - very rapid speeds
 - reduced operational noise
 - very long maintenance intervals
 - long service life
 - scratch resistant surface
- Individual slats can easily be replaced as required.

Door Construction

The self-supporting side frames are made from steel profiles. The roll cover is made of aluminum and the motor cover is grey steel. Integrated safety limit switches provide the interface with the machine control system.

- 2 potential-free safety contacts, when the door is closed (safety limit switch)
- 1 output or potential-free signal, when the door is open
- 1 output or potential-free signal when the door is closed
- 1 output or potential-free signal for faults

Door Curtain

The slats are made of anodised aluminum as standard. They can be equipped with windows made of polycarbonate (250 x 40 mm) as an option. Number of windows depends on the door width.

Control System

The door is operated with the powerful MCC control system that allows high dynamic opening and closing speeds up to 2.0 m/s or 1.2 m/s, which means extremely short cycle times.

Manual Activation

In the event of a power failure the door can be operated by releasing the brake manually. Partial opening takes place automatically via pre-tensioned tensile springs in the side frames.

Indication of Risk/Safety Features

The security of the door is designed for normal use for vehicles in industrial environment corresponding to the harmonized CE-Guidelines. This door is designed according to the regulations of the Workplace Directive of the UVV as well as the harmonized CE Guidelines including the EN 13241-1. Next to this, special environmental conditions may have impact on the right choice of doortype. In case of any doubt, please contact our sales engineer to receive consulting in your application.

Laser Protection

The door was tested in accordance with DIN EN 60825-4. With 2x focal distance and a laser power of 4 kW, a protection period of min. 18 seconds is achieved.

- Option
- ✓ Standard
- * not possible with laser protection

RollTex® based on TRAV (technical regulations for the use of anti-fall protection glazing)

- 1) Height < 2,500 mm, always with cover
- 2) Deviations possible depending on other properties
- 3) Depending on load alternation/minute, door size and installation location
- 4) Extended temperature range on request

TECHNICAL DATA	
Application	Interior door / Machine Protection Door
Door dimensions: DW (min. / max.) LB ²⁾ Door dimensions: DH (min. / max.) LH ²⁾	600 / 4000 mm 1000 / 3500 mm
max. area	12 m ² (9,5 m ² Laser protection)
Speed Open/Close max. (m/s) ²⁾	2,0 / 1,2
Cycles per minute max.	up to 5
Wind resistance (EN 12424)	Class 3 Class 2 (DW > 3000 mm)
Sound pressure level	< 80 dB A
Space requirement top (with lid) / side frame	495-550 / 210-265
Height grid	100 mm
Temperature range max. ³⁾⁴⁾	+10°C to +45°C (0 bis +60°C)
Surface material	
Side frame	✓ Galvanized steel • Powder coated steel *
Top roll cover ¹⁾	• Aluminium • Powder coated
Motor cover ¹⁾²⁾	• Galvanized steel • Powder coated
Lamelle Aluminium	✓ Anodized • Powder coated *
Bottom profile	Standard slat + seal
Safety features	
Electrical safety contact edge ²⁾	•*
Door line photocell in side frame	•
Light curtain (integrated) ²⁾	-
Pre-running safety photocell ²⁾	✓
Manual activation (partial opening)	✓ Pull rope
Counterbalance	Spring force
Equipment	
Light signals and actuators	Separate brochure
Laser Protection (separate conditions)	•
Machine protection	✓
Magnetic switch at the bottom of the side frame	✓ 1 piece • 2 pieces
Windows in side frame (View on magnetic switch)	✓
Additional opening height	•
X-Level	•
Drive unit	
Motor power	Bonfiglioli 1,1 KW
Chain drive (space saving) ²⁾	-
Chain drive (NHK)	•
Control system	
MCC Open/Close max. (m/s) ²⁾	✓ 2,0 / 1,2
Separate display / control	•
Fuse protection by site	10 - 16 A (B-characteristic)
Control voltage	24 V DC
Protection	IP 55
Potential free contacts	•
Power supply	
MCC	380 - 480V (+/- 10%) 50/60Hz
Door Curtain	
Single-walled slat	✓ Anodized aluminium
Double-walled slat (laser protection)	• Anodized aluminium
Slats with windows	• Anodized aluminium
Perforated plate slat	-

General drawing ASSA ABLOY RP2000

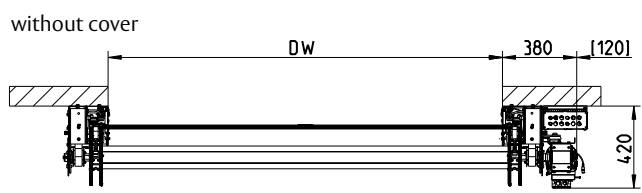
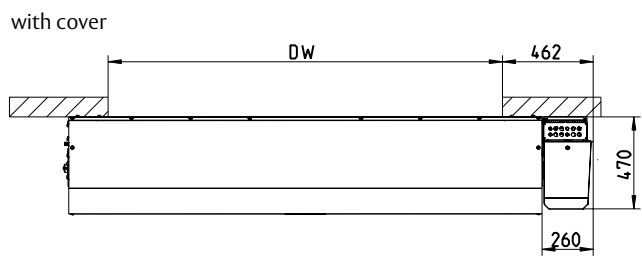
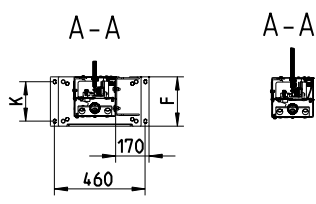
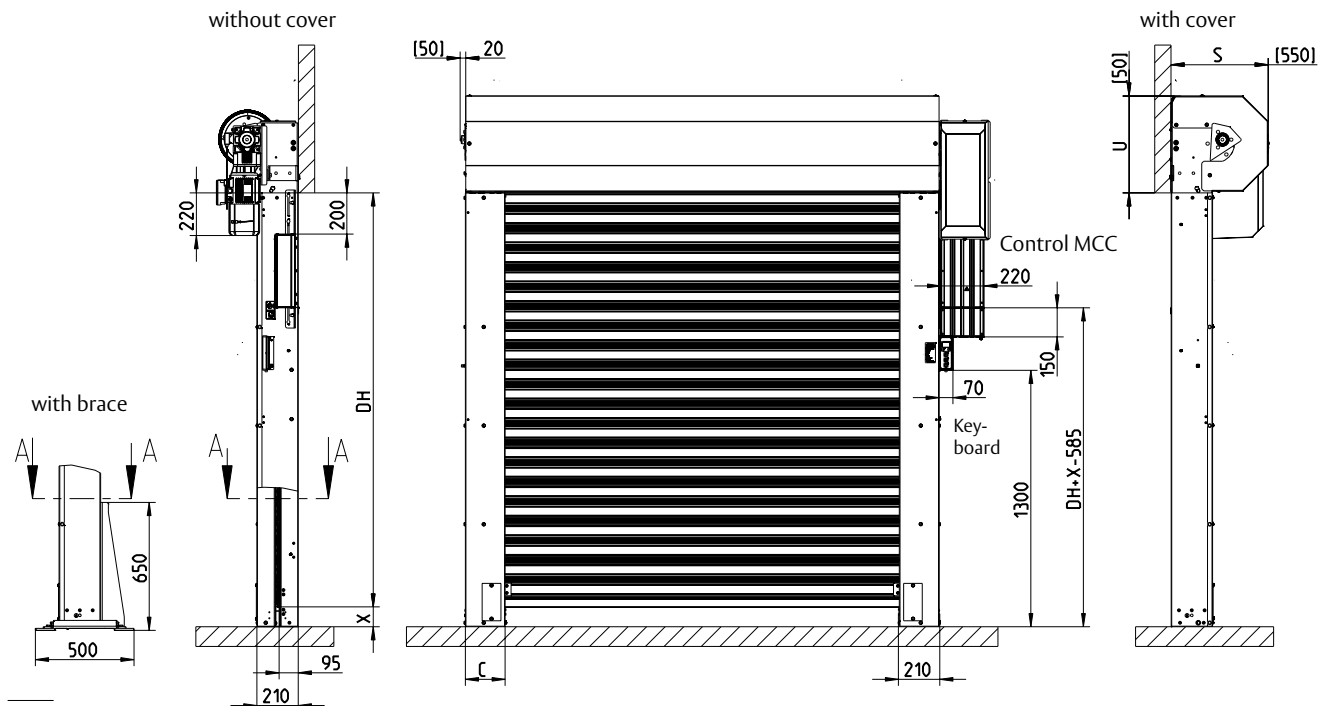

Door type			
	A	B	C
C	210	265	265
U	495	495	550
S	495	495	555
F	250	300	300
K	200	250	250

Door types - standard curtain

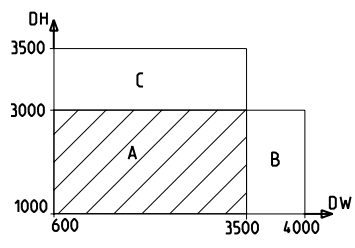

Laser protection curtain

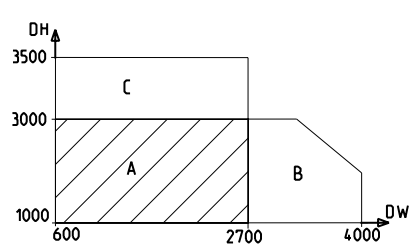

X=X-Level

[] = Space needed for installation

ASSA ABLOY Entrance Systems is a leading supplier of entrance automation solutions for the efficient flow of goods and people. Building on the long-term success of the Besam, Crawford, Albany and Megadoor brands, we offer our solutions under the ASSA ABLOY brand. Our products and services are dedicated to satisfying end-user needs for safe, secure, convenient and sustainable operations.

ASSA ABLOY Entrance Systems is a division of ASSA ABLOY.

ASSA ABLOY

assaabloyentrance.com



ASSA ABLOY Entrance Systems

assaabloyentrance.com

Follow us:



Please enter ASSA ABLOY Entrance in the channel's search field.